

Heatless Desiccant Air Dryers

HHS SERIES, HHL SERIES AND HHE SERIES 40 to 5400 scfm (68 to 9175 nm³/h)



Dedicated to Excellence

Since 1948, compressed air users around the world have relied on Hankison to provide innovative compressed air treatment solutions for critical applications.

Hankison maintains a long standing reputation for manufacturing products that deliver superior performance, time proven reliability and optimal energy savings.

Hankison today is the preferred choice for providing clean, dry compressed air for the most challenging industries.

Based in Charlotte, North Carolina, SPX FLOW is a leading global supplier of highly engineered flow components, process equipment and turn-key systems, along with the related aftermarket parts and services, into the food and beverage, power and energy and industrial end markets. SPX FLOW has more than \$2 billion in annual revenues and approximately 8,000 employees with operations in over 35 countries and sales in over 150 countries around the world. To learn more about SPX FLOW, please visit our website at www.spxflow.com

Hankison's Heatless Desiccant Dryers

THE HHS, HHL & HHE SERIES

Utilizing twin towers filled with premium grade activated alumina, Hankison Heatless dryers are available with three application specific control systems designed to meet the needs of specific industrial applications with economy and performance.

Industries such as pharmaceutical manufacturing, laboratories, hospitals, microelectronics, food packaging, paper, glass and powder painting with low dew point requirements, utilize heatless desiccant air dryers.

Precision Performance

INDUSTRY-LEADING DESIGN

- Consistent outlet pressure dew points
- Premium grade desiccant beads enhance surface area and have high crush strength
- Large desiccant beds ensure 4.8 seconds of contact time
- Large flow diffusers ensure even flow distribution through the bed and eliminate channeling
- Towers are designed to prevent fluidization of the desiccant
- Up-flow drying allows water and heavy contaminants to drop out of the air stream
- Simple discharge of contaminants
- Cleanable stainless steel flow diffusers/support screens
- Separate fill and drain ports for ease of desiccant replacement

INTEGRATED FILTRATION

- Optional pre-filter and after-filter packages, featuring Hankison NGF Series filters, can be pre-installed at the factory
 - Grade SF and Grade HF pre-filters are recommended for -40°F to 38°F (-40°C to 3°C) dew points
 - Grade PF and Grade UF pre-filters are recommended for -100°F (-73°C) dew points
 - Grade PF and Grade CF are the recommended after-filters



PRECISION ACCUSHIFT™ SWITCHING VALVES

- Automatically shift to the low pressure side of the circuit to control process flow
- Position memory ensures drying continues even without power
- 5 year AccuShift valve replacement warranty¹
- Three-way pilot operated solenoid valves manage the pilot air flow to direct the purge/repressurization valves
- Purge pressure adjustment valve

¹ Dryer must be protected by properly sized Hankison prefilter. Parts and labor covered through first year of warranty, parts only in second through fifth years

ENGINEERED-TO-ORDER OPTIONS

- High dew point alarm which includes light and voltage free contacts for remote alarm
- Dew point monitor, includes digital display, voltage-free contacts and recorder output
- Low ambient packages, epoxy paint, severe environment protection
- Oil-free packages with integrated activated carbon towers

SAFETY BUILT TO CODE

- Pressure vessels are CRN and ASME Certified
- Heavy-duty mufflers for quiet operation



Application Specific Designs

HOW IT WORKS

- Phase 1** Moist, filtered compressed air enters the pressurized on-line desiccant-filled drying Tower 1 through the AccuShift™ valve (A)
- Phase 2** Up-flow drying enables the desiccant to strip the air stream of moisture. Clean, dry compressed air exits through AccuShift™ valve (B) to feed the air system
- Phase 3** When in regeneration mode, Tower 2 depressurizes to atmosphere through the muffler (C) when the valve (D) opens
- Phase 4** A portion of dry compressed air (purge air) is diverted before exiting (B) and passes through off-line Tower 2 and exits at valve (D) to desorb the moisture from the desiccant. Once desorbed, valve (D) closes and Tower 2 is repressurized
- Phase 5** At tower shift-over, valve (E) will open, causing AccuShift™ Valves (A & B) to shift
- Phase 6** Tower 2 will be placed on-line to dry the bed. Operations will switch and Tower 1 will be regenerated

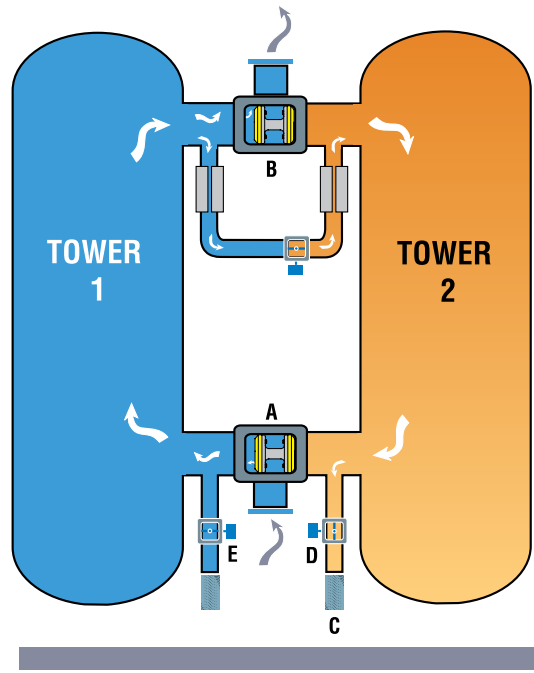

MATCH PERFORMANCE BY DEMAND

Three user selectable designs engineered to balance economy and performance.

Ideal for applications that operate with a large swing in air demands due to variations in production scheduling or shifts of operation. Some applications operate at a fraction of the flow of the compressor due to air system efficiency improvements. Some applications operate continuously at-or-near full capacity.

HHS Series
For Fluctuating Demands (1 to 3 shifts)



HHS or HHE Series
For Peak Demands (1 to 3 shifts)

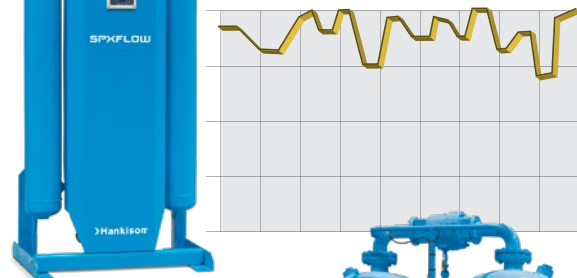

HHS or HHL Series
For Reduced Demands (1 to 3 shifts)

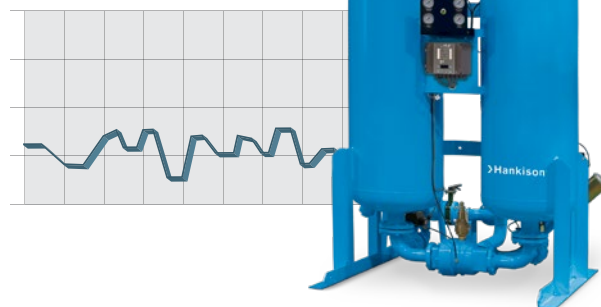

HHS Series Desiccant Dryers

AUTOMATIC SENSATHERM® ENERGY SAVINGS

Hankison's HHS Series with patented SensaTherm automatically matches purge air to plant air demand. This ensures maximum performance as the saved energy goes right to your bottom line.

When operating at reduced capacity, the on-line drying tower remains active longer, until its full drying capacity is utilized. Desiccant bed temperature changes are constantly monitored within each tower to precisely manage drying times and reduce purge air consumption.

SensaTherm also measures the increase in desiccant bed temperature (heat of adsorption) during the drying stage and the decrease in desiccant bed temperature (heat of desorption) during the regeneration stage. These temperature changes are accurate indicators of the moisture load on the dryer. This data is interpreted by microprocessor based controls to determine how long a tower stays on-line during the drying stage.

Advantages:

- Temperature transducers (thermistors) are used as sensing devices. They are simpler, more reliable and more rugged than competitive designs.
- Sensors require no calibration.
- The system is based on saving the heat of adsorption, towers switch before heat is lost maximizing purge air efficiency and minimizing the amount of purge air required.

HHS SERIES CONTROLLER FEATURES:

- Choice of three operating modes
- Switches for On/Off, Alarm and Service reminder reset
- Operational LED lights for power-on, tower status, valve status, and tower pressure
- Service reminder LED lights for filters and drains, valves and desiccant. The user selects between a Normal and a Severe service interval
- Alarm LED for tower switching failure, filter monitor signals, electronic demand drain alarms on filters
- USB Flash Drive for Data Tracking & Storage: Records; State Changes, Power Loss, Alarms w/ Timestamp
- High-visibility Vacuum fluorescent text display communicates energy savings, operating mode and service reminders
- Ethernet communication
 - Web interface (HTTP)
 - Modbus (TCP)

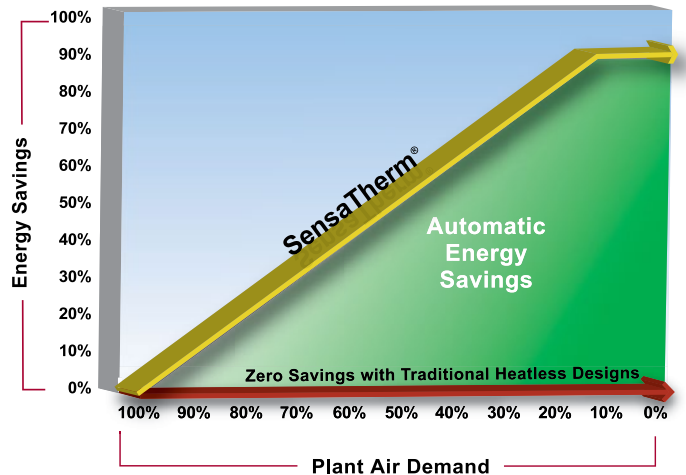

Maximize your return-on-investment automatically. HHS Series with SensaTherm® delivers energy savings in direct proportion to load variations from your plant air demands, making it the Auditor's Choice.

Automatic Energy Savings

LOAD	ENERGY SAVINGS CONTROL*							
	590	750	930	1,130	1,350	1,550	2,100	3,000
100%	-	-	-	-	-	-	-	-
95%	\$ 741	\$ 941	\$ 1,167	\$ 1,418	\$ 1,694	\$ 1,945	\$ 2,636	\$ 3,765
90%	1,481	1,883	2,335	2,837	3,389	3,891	5,271	7,531
85%	2,222	2,824	3,502	4,255	5,083	5,836	7,907	11,296
80%	2,962	3,765	4,669	5,673	6,778	7,782	10,543	15,061
75%	3,703	4,707	5,836	7,091	8,472	9,727	13,179	18,827
70%	4,443	5,648	7,004	8,510	10,166	11,673	15,814	22,592
55%	6,665	8,472	10,505	12,764	15,250	17,509	23,722	33,888
40%	8,886	11,296	14,007	17,019	20,333	23,345	31,629	45,184
25%	11,108	14,120	17,509	21,274	25,416	29,181	39,536	56,480

* Assumes 5 scfm/HP, 8,760 hours of operation per year, \$ 0.10 kW/h

Full complement of Function Indicator LEDs Filter Service Indicator LEDs

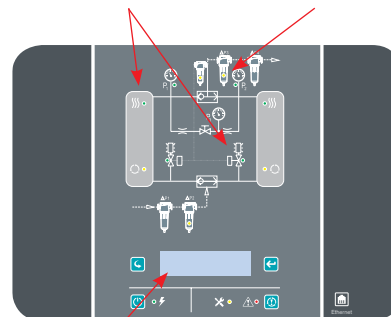

Controller Displays Energy Savings, Cycle Modes, Dew Point Selection, Service Reminders, and Alarm Conditions

HHL Series & HHE Series Desiccant Dryers

HHL SERIES

Selectable Purge Economizer Savings

HHL Series provides user selectable energy savings with tailored drying cycles designed to match your peak air demands.

Reducing the amount of time the dryer spends purging in the regeneration cycle can save energy. Eight settings (0% to 70% in 10% increments) are furnished for users to lower the purge to match reduced air loads on the dryer. Each energy saving setting has an LED light which will illuminate when it is selected. Simply flip the switch to select the desired energy saving setting.

In addition, this state-of-the-art controller offers four pressure dew point settings to further tune your savings and adapt the system to your environment.

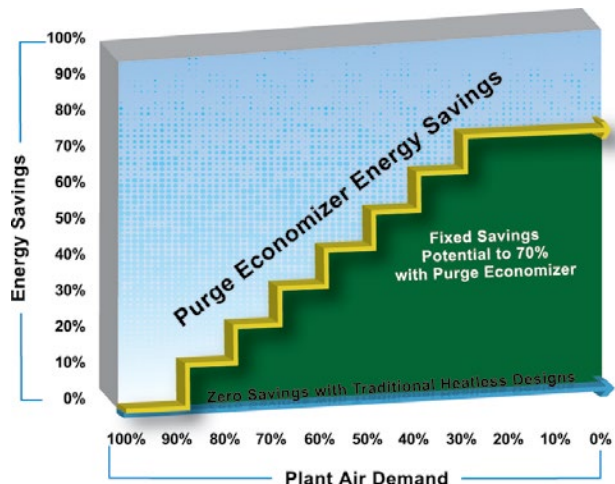

Purge Economizer lets you align your purge costs with your air demands to optimize your return-on-investment. Tailor HHL Series dryers to take full advantage of air system efficiency improvements driven by air audit strategies.

HHL CONTROLLER FEATURES:

- Choice of four fixed cycle operating modes corresponding to ISO 8573.1 Air Quality Classes
- Choice of eight Purge Economizer Energy Savings settings
- Switches for On/Off, Alarm and Service reminder reset
- Operational LED lights for power-on, tower status, valve status, and tower pressure
- Alarm LED for valve switching failure
- RS-232 communications port is standard
- Service reminder LED lights for filters and drains, valves and desiccant

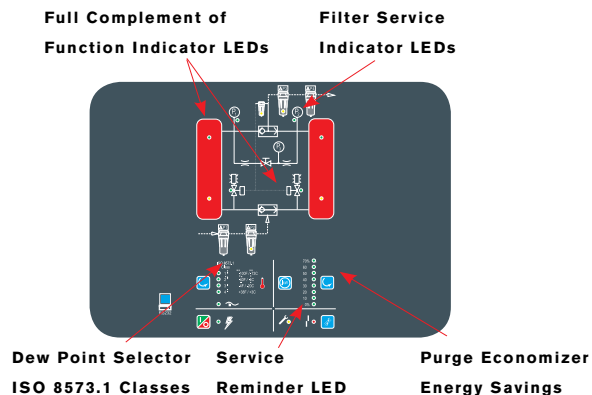

HHE SERIES

Basic Fixed Control - One fixed cycle mode corresponding to ISO 8573.1 Air Quality Class 2

Hankison's HHE Series is engineered to address the need for raw performance and value. This traditional design uses a simple timer to alternate the flow between the two towers filled with premium grade desiccant. These are designed to deliver maximum value to applications that operate at-or-near full capacity.

Automatic time controlled bed regeneration cycles offer consistent performance and economy of purchase. While the on-line tower is drying the air stream, the off-line tower purges a fixed amount of compressed air to dry the bed and prepares it for the next drying cycle.

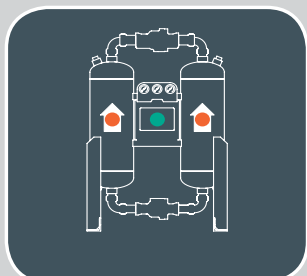

HHE CONTROLLER FEATURES:

- Control Panel overlay with LED's indicating:
 - Power On
 - Left Tower Drying
 - Right Tower Drying

Product Specifications

MODEL	INLET FLOW @ 100 PSI (6.7 BAR)		DIMENSIONS						INLET / OUTLET CONNECTIONS 1	WEIGHT LBS
	SCFM	NM ³ /H	H		W		D			
			IN	MM	IN	MM	IN	MM	IN	
HHS/HHL/HHE-40	40	68	46	1,168	32	813	32	813	1" NPT	365
HHS/HHL/HHE-60	60	102	61	1,549	32	813	32	813	1" NPT	445
HHS/HHL/HHE-90	90	153	78	1,981	32	813	32	813	1" NPT	575
HHS/HHL/HHE-115	115	195	54	1,372	44	1,118	38	965	1" NPT	685
HHS/HHL/HHE-165	165	280	54	1,372	44	1,118	38	965	1" NPT	685
HHS/HHL/HHE-260	260	442	72	1,829	49	1,245	38	965	2" NPT	1,010
HHS/HHL/HHE-370	370	629	63	1,600	55	1,397	38	965	2" NPT	1,215
HHS/HHL/HHE-450	450	765	71	1,803	55	1,397	38	965	2" NPT	1,350
HHS/HHL/HHE-590	590	1,002	101	2,565	50	1,270	53	1,346	2" NPT	1,473
HHS/HHL/HHE-750	750	1,274	109	2,769	51	1,295	48	1,219	3" ANSI FLG.	2,134
HHS/HHL/HHE-930	930	1,580	113	2,870	56	1,422	56	1,422	3" ANSI FLG.	2,414
HHS/HHL/HHE-1130	1,130	1,920	113	2,870	59	1,499	56	1,422	3" ANSI FLG.	2,875
HHS/HHL/HHE-1350	1,350	2,294	118	2,997	60	1,524	56	1,422	3" ANSI FLG.	3,722
HHS/HHL/HHE-1550	1,550	2,634	113	2,870	66	1,676	56	1,422	3" ANSI FLG.	4,167
HHS/HHL/HHE-2100	2,100	3,568	116	2,946	73	1,854	56	1,422	4" ANSI FLG.	4,417
HHS/HHL/HHE-3000	3,000	5,097	122	3,099	78	1,981	65	1,651	4" ANSI FLG.	9,010
HHS/HHL/HHE-4100 ²	4,100	6,966	124	3,150	93	2,362	88	2,235	6" ANSI FLG.	9,900
HHS/HHL/HHE-5400 ²	5,400	9,175	126	3,200	102	2,591	92	2,337	6" ANSI FLG.	12,000

Maximum Working Pressure: 150 psi (10.5 bar) standard, 250 psi (17.6 bar) optional. Units with higher Maximum Working Pressures are available.

Minimum Operating Pressure: 150 psi (10.5 bar) units - 60 psi (4.2 bar), 250 psi (17.6 bar) - 120 psi (8.4 bar)

Maximum Inlet Air or Ambient Air Temperature: 120°F (49°C)

Pressure Drop at Rated Flow: Less than 5 psi (0.35 bar)

Available Voltages: HHE - 100-120V/1ph/50-60Hz, HHL/HHS - 100-240V/1ph/50-60Hz and 12-24 VDC, NEMA 4 Standard Pressure Drop at Rated Flow: Less than 5 psi (0.35 bar)

Dimensions and weights are for reference only. Request certified drawings for construction purposes.

1 BSP and DIN flanges available

2 Supplied with Premium Quality Butterfly Switching Valves

Four Dew Point Options per ISO 8573-1 Air Quality Standards

DEW POINT	ISO 8573-1 QUALITY CLASS			
	1	2	3	4
	°F	-100°	-40°	-4°
°C	-73°	-40°	-20°	3°
REMAINING MOISTURE	ppmw	10	81	610
mg/m ³	0.12	12	97	730
HHS SERIES	4 min. fixed	Demand or 10 min. fixed	Demand or 16 min. fixed	-
HHL SERIES	4 min. fixed	10 min. fixed	16 min. fixed	24 min fixed
HHE SERIES	-	10 min. fixed	-	-

Specifying a pressure dew point is not simple work for an engineer. Hankison Heatless dryer designs allow you to optimize performance and dew points in the field to adapt to your environment and meet the following ISO 8573-1 Classes of air quality.

HHS, HHL & HHE Series

40 to 5400 scfm
(68 to 9175 nm³/h)



Inlet Flow

Inlet flow capacities are established in accordance with CAGI (Compressed Air and Gas Institute) standard ADF-200: Inlet air pressure 100 psi (6.7 bar), inlet temperature saturated at 100°F (38°C). To determine inlet flow at pressures other than 100 psi (6.7 bar), multiply inlet flow at 100 psi (6.7 bar) from Product Specifications by the corresponding multiplier in Table 1.

Table 1

PRESSURE		MULTIPLIER
PSI	BAR	
60	4.13	0.65
70	4.83	0.74
80	5.52	0.83
90	6.21	0.91
100	6.89	1.00
110	7.58	1.04
120	8.27	1.08
130	8.96	1.12
140	9.65	1.16
150	10.34	1.20
175	12.06	1.29
200	13.78	1.37
225	15.51	1.45
250	17.24	1.52

SPX FLOW

4647 SW 40th Avenue

Ocala, Florida 34474-5788 U.S.A.

P: (724) 745-1555

F: (724) 745-6040

E: hankison.americas@spxflow.com

www.spxflow.com/hankison

SPX FLOW, Inc. reserves the right to incorporate our latest design and material changes without notice or obligation.

Design features, materials of construction and dimensional data, as described in this bulletin, are provided for your information only and should not be relied upon unless confirmed in writing. Please contact your local sales representative for product availability in your region. For more information visit www.spxflow.com.

The green "S" and "X" are trademarks of SPX FLOW, Inc.